

PRM-0XX or PRM-1XX FRONT SEAT HEATER KIT WIRING DIAGRAM

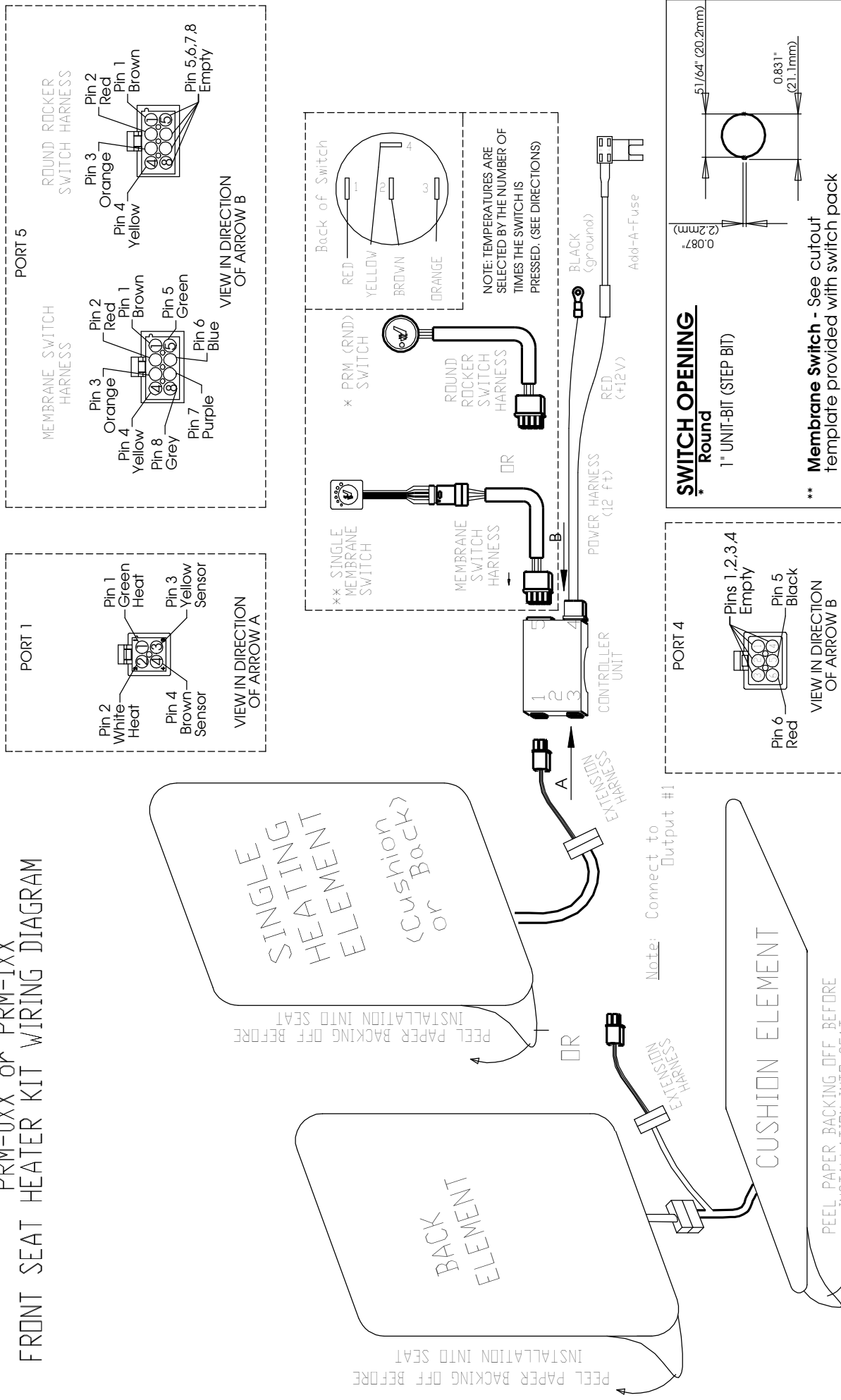

PRM-2XX FRONT SEAT HEATER KIT WIRING DIAGRAM

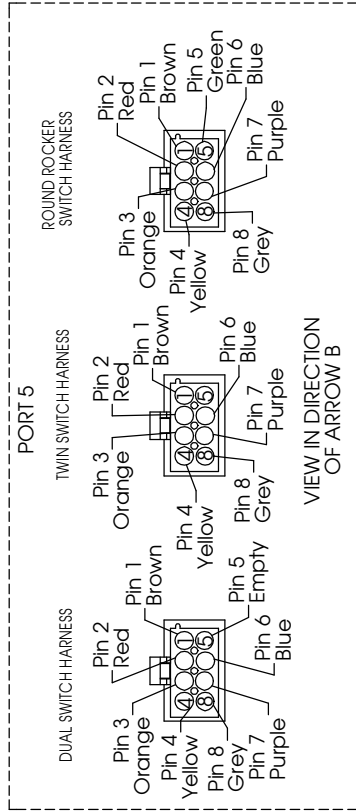
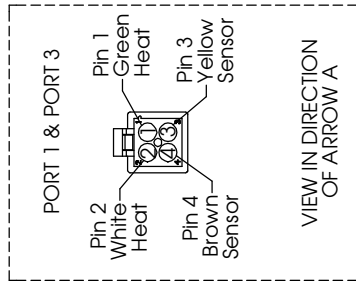
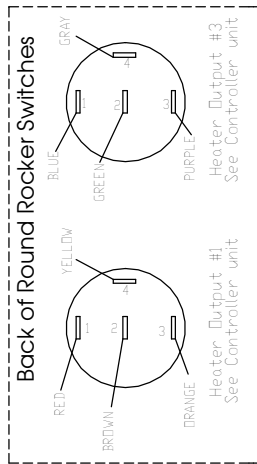

NOTE: TEMPERATURES ARE SELECTED BY THE NUMBER OF TIMES THE SWITCH IS PRESSED. (SEE DIRECTIONS)

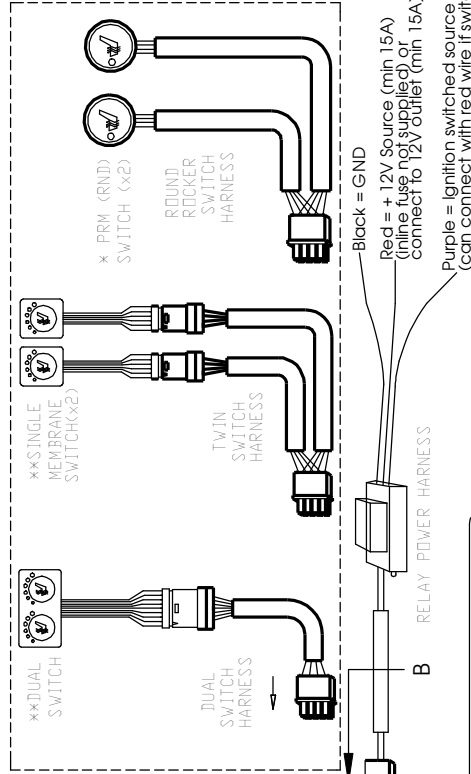

SWITCH OPENING



** Membrane Switch - See cutout template provided with switch pack

diagLIT-FST-2 REV H 11/14/11

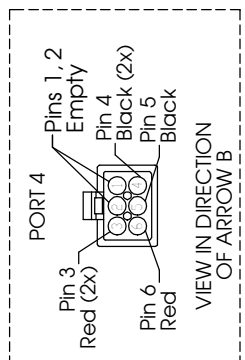
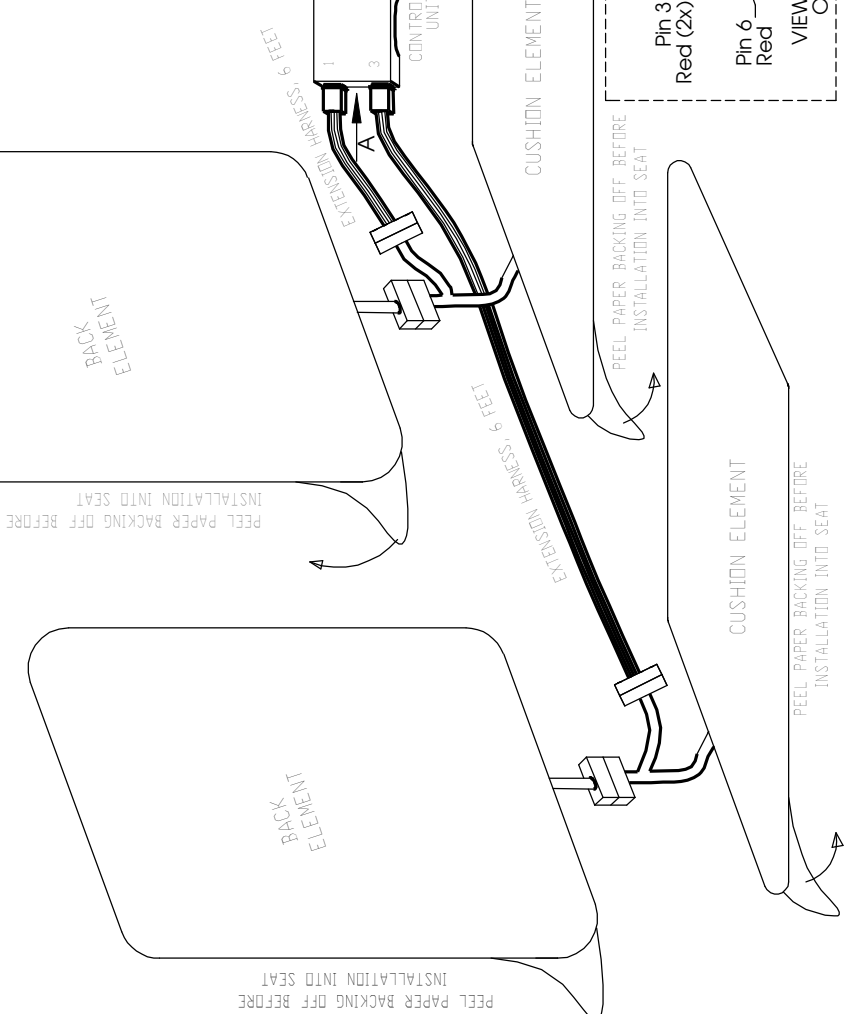

PRM-3XX FRONT SEAT HEATER KIT WIRING DIAGRAM

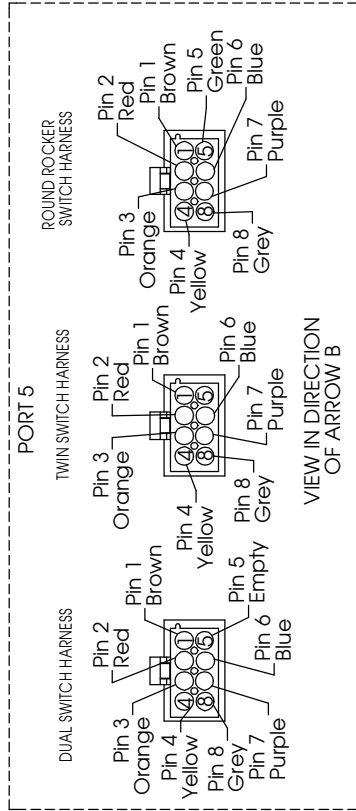
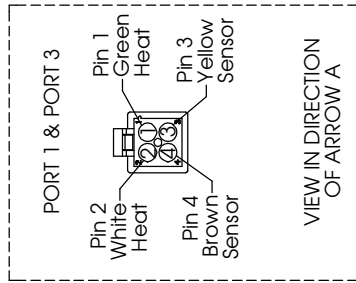
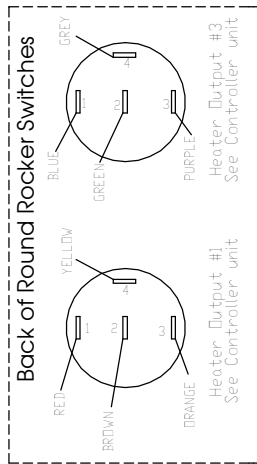

NOTE: TEMPERATURES ARE SELECTED BY THE NUMBER OF TIMES THE SWITCH IS PRESSED. (SEE DIRECTIONS)

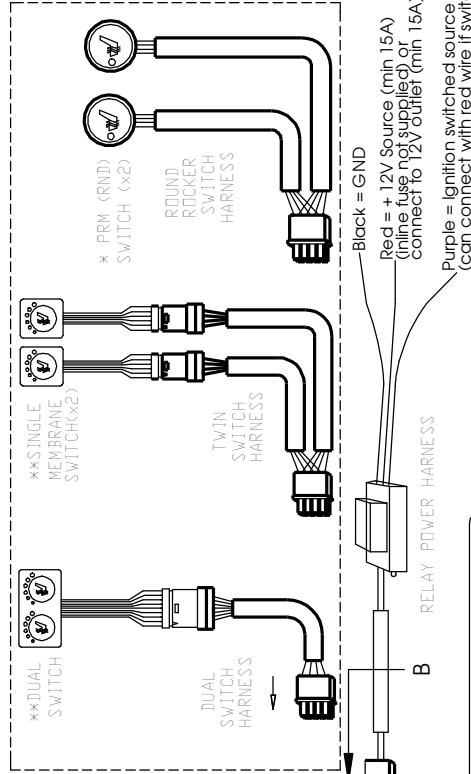

** Membrane Switch - See cutout template provided with switch pack

diagLIT-FST-2 REV H 11/14/11

